

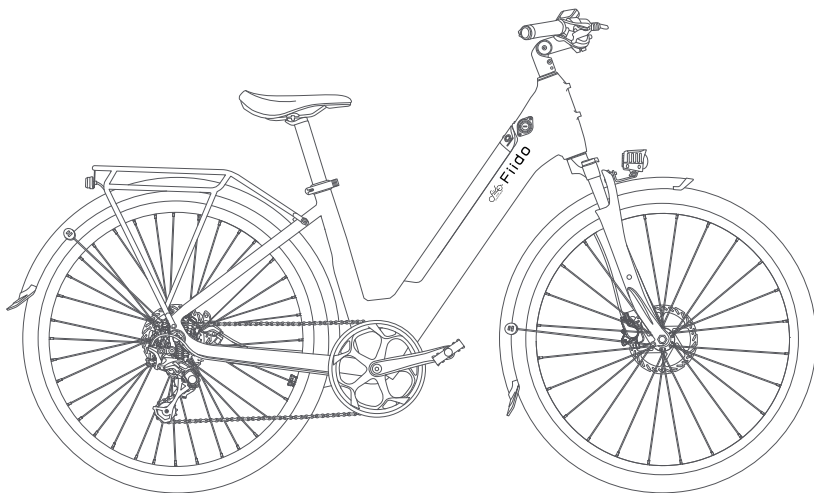

# Fiido C11

## Electric Bike



Dear users, please read this manual carefully before operating the bike.  
WARNING: DO NOT OPERATE THE BIKE BEFORE UNDERSTANDING HOW TO USE IT.

## Dear user:

In this manual, we will introduce the the key features of the bike and give you some advice on how to use and maintain the Fiido C11.

Please make sure that you understand everything carefully. If you have any questions, please contact [support@fiido.com](mailto:support@fiido.com), our customer care team will get in touch with you shortly.

## Safety precautions

1. Please follow the precautions in this instruction to effectively reduce risks. When entering public areas, please obey national and local regulations, remain vigilant while riding, and maintain a reasonable safe distance from other people and vehicles.
2. Please operate by the instruction of the user manual, the loss caused by not following the instructions shall be borne by oneself.
3. This product is not professional off-road bike, do not use this product according to off-road standards.
4. For the first time riding, please keep away from children, pedestrians, pets, vehicles, or other obstacles and potential hazards. Please be familiar with the bike before riding on public main roads.
5. Before each ride, please carefully check the parts and screws of the bike to make sure it is working well. If there's any unusual noise, please stop riding immediately, and contact after-sales team for help.
6. To avoid injuries, please read and follow all "Caution", "Danger" and "warning" instructions in this user manual. Please don't speeding, and do not ride in motorized road under any circumstances.
7. For safety consideration, user must be over 16 years old. Users under the following circumstances are strongly not recommended to use this product:
  - People affected by alcohol or drugs.
  - People who are unable to engage in strenuous physical activity due to illness.
  - People who are unable to maintain balance or whose balance is impaired by motor skills.
  - People whose weight exceeds the max load limit (max load is 120KG/265lb).
  - Pregnant woman.

8. Please ride carefully in snow, rain, wet road, ice and other bad weather. Do not ride over too high or too large obstacles, otherwise it's very likely to lose balance or grip and cause injuries.
9. Do not attempt to charge while the charger or power supply is wet, please follow the local safety regulations if you need to charge the bike in public area.
10. For effective protection and as convenient as possible for yourself, please be sure to use Fiido specific parts.
11. If you need to retrofit your bike, Please follow the local laws and regulations, after consulting with Fiido after-sales team, then proceed with caution. Serious injury and/or damage caused by unauthorized modification will result in the void of warranty.

# CONTENTS

## **1. Product introduction**

- 1.1 Bike overview
- 1.2 Packing list
- 1.3 Bike diagrams
- 1.4 Function DESC

## **2. How to use**

- 2.1 Installation guide
- 2.2 First time using
- 2.3 Charging instructions
- 2.4 Battery removal and installation

## **3. Regular Maintenance**

- 3.1 Using precautions
- 3.2 Bike maintenance & repair
- 3.3 Motor maintenance & repair
- 3.4 Battery maintenance & repair
- 3.5 Reflex reflector cautions

## **4. After-sale Service**

- 4.1 Troubleshooting methods
- 4.2 Specifications
- 4.3 Warranty coverage
- 4.4 Repair record

\* All pictures are for reference only.

# **1.Product introduction**

1.1 Bike overview

1.2 Packing list

1.3 Bike diagrams

1.4 Function DESC

# 1.1 Bike overview

Aiming to bring the most artistic and innovative e-bikes at affordable prices, Fiido, following the success of the Fiido E-gravel series, introduced the Fiido C11. This model is equipped with the most significant innovations for a city e-bike. It features a sleek frame design in colors chosen by the Fiido team, a removable battery on the tube, and a full-color display, ensuring a stylish and enjoyable ride.

Rider safety is our top priority. The C11 comes with hydraulic brakes to provide ample stopping power. Equipped with a powerful 55N·m motor, anti-puncture tires, and a shock-absorbing front fork, along with a comfortable Velo saddle, this setup provides riders with enhanced confidence to tackle a variety of road conditions.

To enhance the riding experience, the C11 continues the tradition of phone and Fiido watch connectivity for bike and proximity start features from the E-gravel series.

The Fiido C11 represents an excellent value and is a smart choice for those seeking to evolve their mode of transportation within a budget.

# 1.2 Packing list

## Bike parts

---

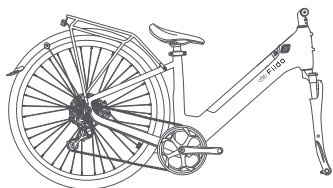

Electric Bike\*1

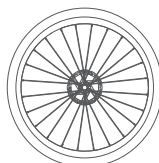

Front wheel\*1



Handlebar\*1

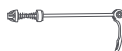

Front wheel quick release\*1



Key\*2

## Bike accessories

---



Front light\*1



Fenders\*1



Charger\*1



Pedals\*1



User manual\*1

## Tools

---

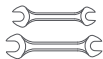

Open spanner\*2



Hex wrench\*8



Y-Type Allen Wrench\*1



Screwdriver\*1

\*Please carefully check whether all items are complete and intact. If there is any problem such as missing or damaged, please contact the official after-sales team asap.

# 1.3 Bike Diagrams

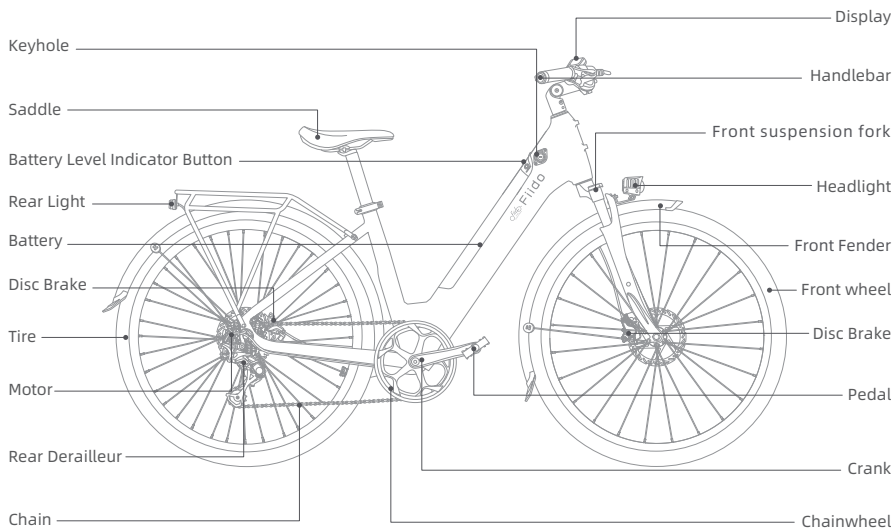

\*Non professionals are forbidden to assistance and assemble the battery.  
Please contact after-sales team for assistance.



# 1.4 Function DESC

## Handlebar

### APP Connection Indicator

(When the bike connects with the phone successfully, the Bluetooth icon will be shown.)

### Speed

(Displays current speed.)

### Battery Status

(Displays battery level.)

### Headlight/Gear Switch

① Single click to switch up the assist level.  
② Double click to turn on/off the headlight.

③ Press three times: Activate the boost function; pressing the brake will exit this function.)

### Power Assisted Level Switch

① Single click to switch down the assist level.  
② Double-click to switch kmh/mpH display.  
③ Long press for 3 seconds, when the speed display enters the flashing state, the cruise control function can be started/turned off.)

### Horn

(In case of overtaking, road section affecting safety visibility or emergency, slow down and ring the bell for signal.)

### Power-on Button

① Click to switch the display of the data.  
② Long press for more than 3 sec: turn on/off the power.)

### Cruise Control Indicator

(Keep the throttle steady for around 8 seconds to turn on cruise control, and the icon will light up. Brake or change the throttle to turn off cruise control, and the icon will go off.)

### Fiido Watch Connection Indicator

(To connect the Fiido Mate cycling watch, please press the button "A" and "V" at the same time and hold for 3 seconds. The Bluetooth connection icon will blink during the connection process. Once connected, the icon will remain solid.)

### Boost Icon

(When the boost function is activated by pressing the "⚡" button three times, this icon will be displayed. The icon will turn off when the brakes are applied.)

### Power Assisted Level Display

(Display the current power assisted gear.)

### Power Cut-off Brakes

(When the brakes engaged, the throttle will not function.)

### Speed Gear Display

(Pull the handle outward to shift up.)

### 7Speed Shift Up

(Pull the handle outward to shift up.)

### 7Speed Shift Down

(Pull the handle outward to shift down.)

### Electric mode button

(Gently press down the button to switch to the pure electric mode, the stonger the press, the faster the speed.)

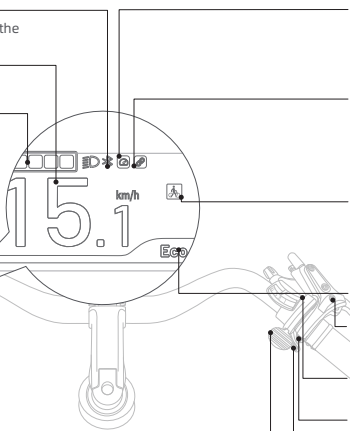

## Battery

### Battery Level Indicator Button

Press the battery button to illuminate the battery level indicator with different bars of lights, representing the following battery levels:

- 4 bars: More than 75%
- 3 bars: More than 50%
- 2 bars: More than 25%
- 1 bar: Below 25%

### Power Switch

Turn on the battery power by pressing the switch; pressing it again will turn off the battery power. (Note: If the ebike is not used for an extended period, please turn off the battery switch to prevent battery damage due to power depletion.)

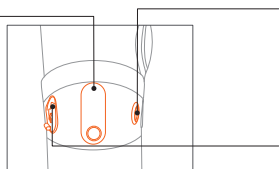

### Charging Port

(Insert the Fiido charger ONLY.)

## **2.How to use**

2.1 Installation guide

2.2 First time using

2.3 Charging instructions

2.4 Battery Removal &Installation

## 2.1 Installation guide

Most parts of the bike had been installed from the factory. But please install the handlebar.baskets,headlight, front wheel, fenders,pedals and adjust the saddle before riding.

### Install the handlebar

---

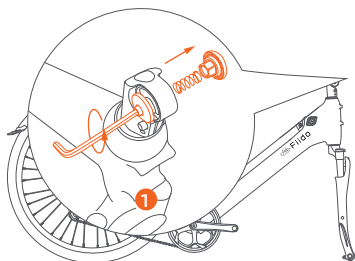

- ① Use the Allen key to remove the counter-locking screws from the stem.

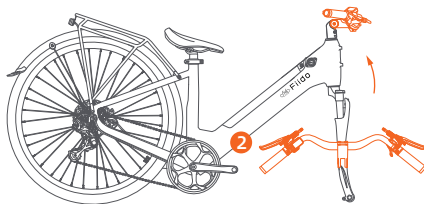

- ② Remove the handlebars and adjust the position to make the brake levers align with the direction of the front wheels.

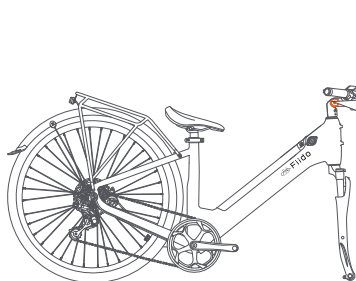

- ③ Insert the handlebar into the stem holes and align with the risers.

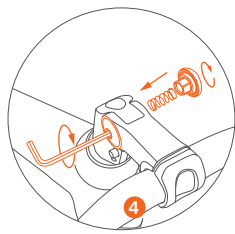
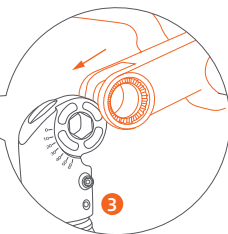

- ④ Lock the counter-locking screws and use an Allen screw tool to lock it safety.

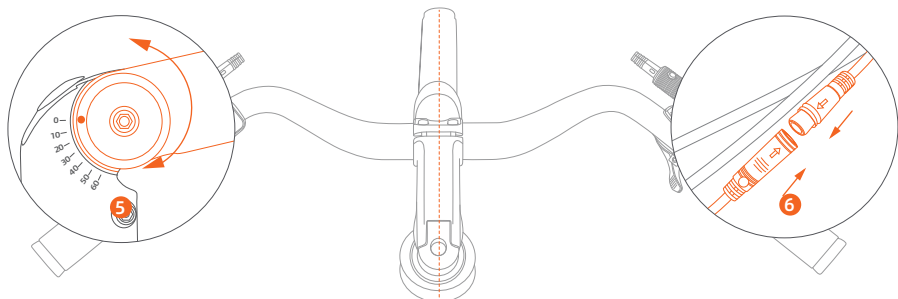

- ⑤ Adjust the angle of the handlebar upturn, the default angle is 0°; you can adjust it to fit your riding habit; (Check if the direction of the handlebar and the front wheel can be aligned, if not, you can loosen the 2 screws on the side of the handlebar to adjust.)
- ⑥ Install the handlebar wire: Follow the color of cable connector, and align the connector arrow direction to access the handlebar. (Caution: The screws should be tightened to keep safe.)

## Install the front wheel



- ① Unscrew the nut and spring of the front wheel quick release.

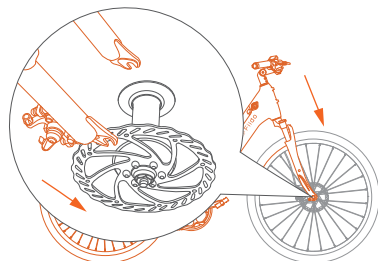

- ② Lift the front part of the bike, align the front wheel and insert the front fork sleeve ring.

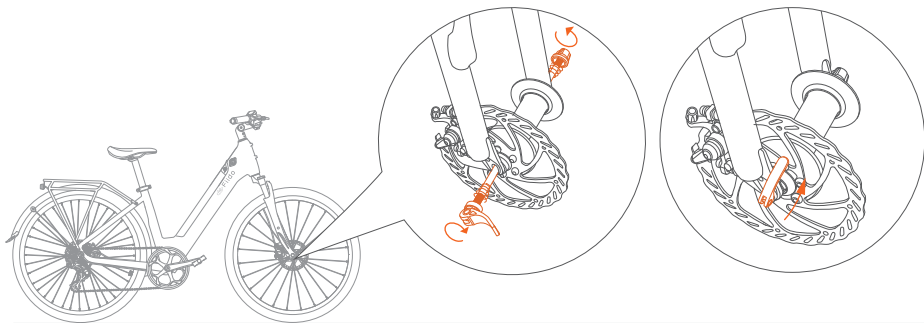

- ③ Put the front axle through the front wheel, and load the spring, screw the nut, lock the front wheel quick disassembly.

## Install Fenders&Headlights

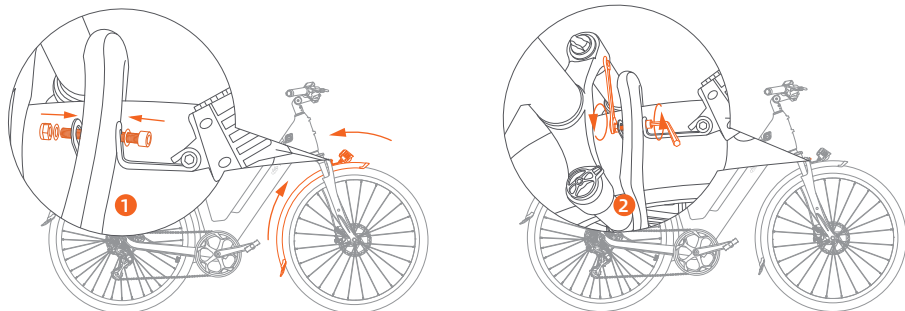

- ① Pass the front fender through the rear of the front fork, and put the headlight into the front of the front fork and pass the screws (the direction of the headlight is as shown in Fig.)

- ② Use the open-end wrench and Allen tool to lock the screws and nuts.

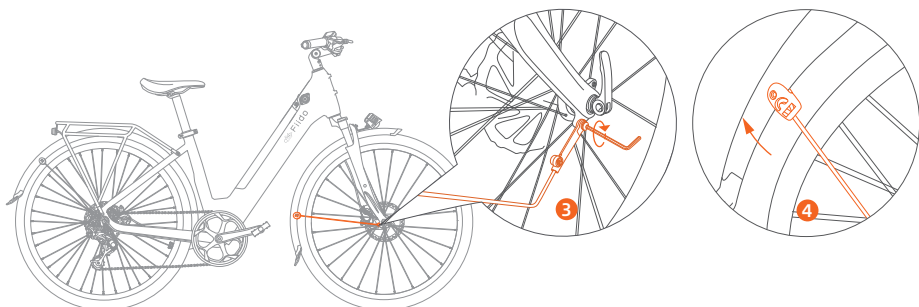

③ Place the fender stand clips towards the front tire and lock the stands to the front fork.

④ Fit the Fender stands into the fender by clipping.

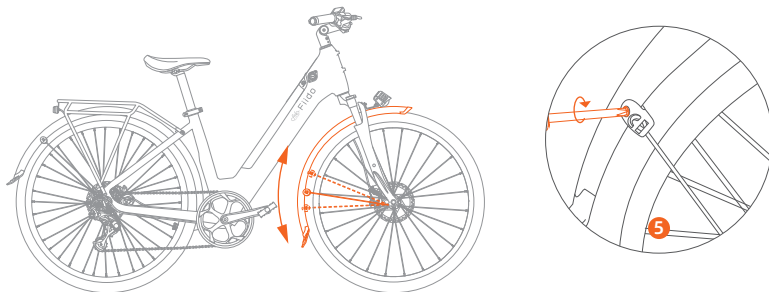

⑤ Adjust the angle of the fender stand position to keep the fender at a certain distance from the tire, then use the self-tapping screws to lock the stands.

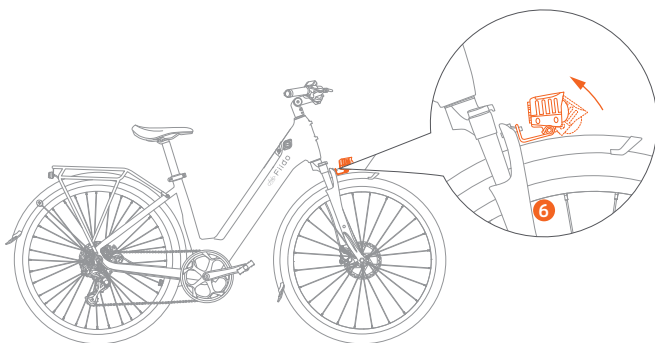

⑥ Adjust the headlight angle and lock with screws.

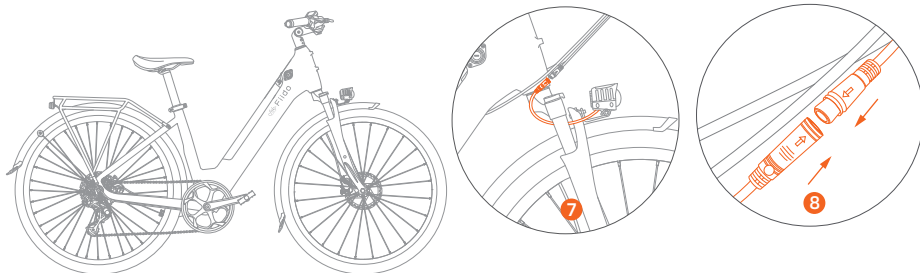

⑦ Place the headlight cable through the center of the fork to the back of the fork.

⑧ Connect the sockets in same colours to finish installation.

## Install pedals

---

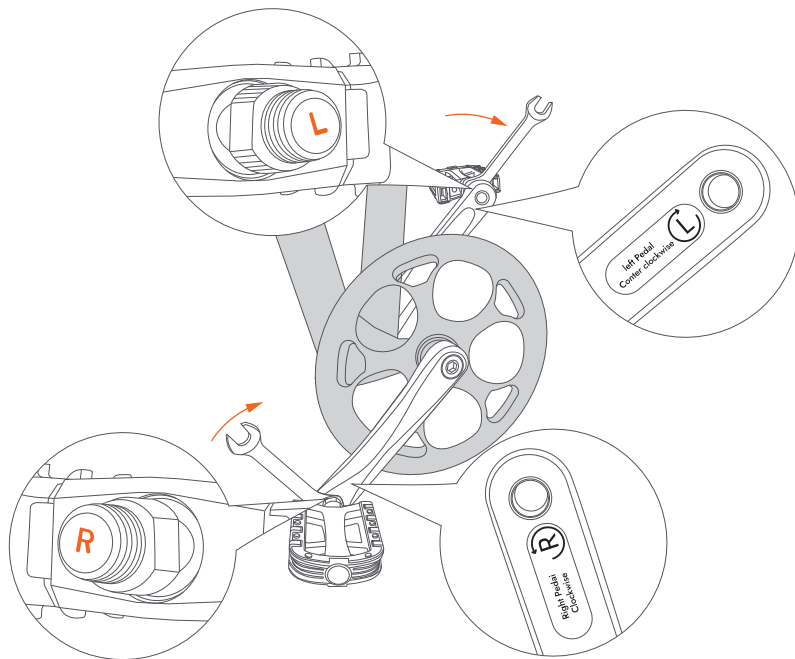

Use the open spanner of the tools bag, screw the pedal shaft into the threaded hole and tighten it in the direction of the arrow.

Caution: While installing the pedal, pay attention to the left / right pedal corresponding to the left / right crank, the pedal screw and the inside of the crank are respectively marked L(left) / R(right). Please install the pedal correctly to prevent it from sliding out of the crank.



## 2.2 First time using

Before riding, please follow the installation guide to install components properly, check whether the firmware is loose, ensure sufficient power, and take appropriate protection for riding.

### Step 1: Adjust the seat

Please adjust the seat to the appropriate riding height according to your height.  
(The recommended height is when the saddle is level with the user's pelvis when standing naturally.  
The height of the adjustment can NOT exceed the safety line.)

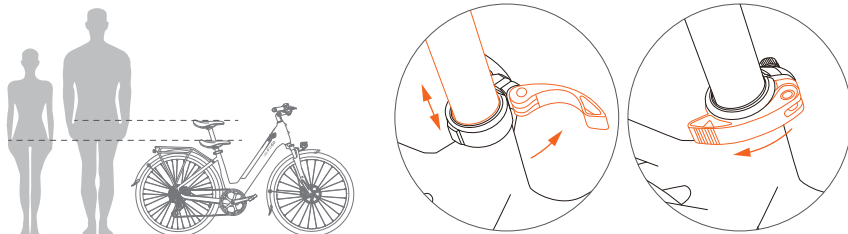

### Step 2: Turn on the power and adjust the suspension fork

- ① long press the “” button of the display to turn on the bike power.
- ② Adjust the front shock absorption according to riding requirements: rotate the left button of the front fork to the direction of “+” to harden the front fork (faster rebound speed). Rotate to the direction of “-” to soften the front fork (slower rebound speed).

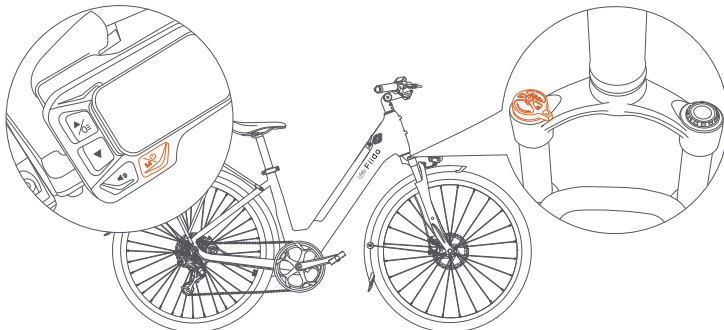

### Step 3: Adjust the power assisted gear

Switch and choose the riding mode according to the cycling road conditions and personal needs.

- ① Electric mode: Equipped with pure electric mode, gently press down the electric mode button to switch to the pure electric mode, the stonger the press, the faster the speed.
- ② Power assisted mode: Equipped with 5 power assisted gears, click the power assisted gear button to switch the gear. The 1st gear is suitable for relatively flat road conditions, the more/higher the road slope, the larger gear can be adjusted accordingly.

Attention: When the bike is on PAS 3/5 status, click the power assisted gear button again and the bike will be on PAS 0 status, by then the gear display won't be lighted and the The motor will be tuen off. But other components can work as well. The bike will be on pedalling mode.  
The bike has been factory settings in 3 power-assisted gear, if you need to set it in 5 power-assisted gear, please download Fiido APP and operate it.

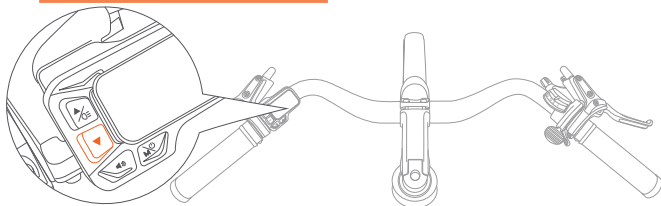

### Step 4: Start riding

Please take corresponding protection before starting riding.

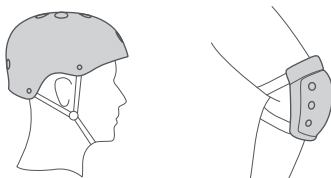

### Step 5: Braking introduction

The left side is front brake, the right side is rear brake. (The UK version: Left side for rear brake right side for front brake.)

Caution: While riding, it's recommended to use the rear brake first, then the front brake to slow down the speed to stop, in order to avoid falling accident caused by balance problems from urgent front wheel brake.

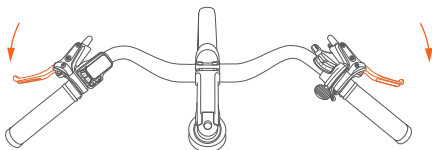

## 2.3 Charging instructions

The battery comes with a small amount of electricity, before the first time use, please make sure to charge it to full power before riding.

### Charging

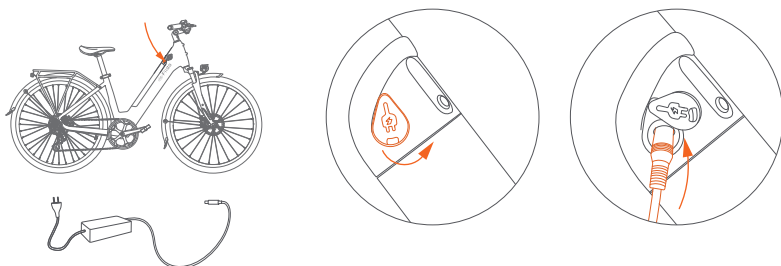

1. Charging connection: Connect the charging interface of the charger to the charging port, then connect the power plug of the charger to the power socket.
2. Fully charged: When the indicator light of the charger is red, means it's normal charging. When the light is green, means it's fully charged.
3. Charging hour: Charging hour is around 5-7 hours, The duration depends on the situation.
4. Disconnect charging: When the indicator light turns green, means it's fully charged. Unplug the power plug first, then remove the charging interface from the battery. Close the battery dust cover.
5. Charging mode: The bike supports two charging modes: vehicle charging and disassembly battery charging. Please see P16 for how to remove the battery.

**Caution:** ① Charger has high voltage device, DO NOT repair without permission. In order to avoid danger, battery and charger should be placed away from children. There should be no inflammable and explosive objects around the batteries (such as car seat cushions, sofas, etc.)

② Keep the battery in a ventilated and dry place, and make sure NOT to charge in open-air place, to avoid electrical short circuit fire and other accidents caused by rain and other factors, and to prevent liquid and metal particles into the electrical parts.

③ Make sure to charge for more than two hours every month under chronically store condition. Do not store the battery at a loss of power. Once the battery voltage reaches the discharge state, will cause unrecoverable damage.

**Danger:** Charging can be allowed on public charging equipment, but the matching between the battery and the charging equipment should be fully considered.

**Warning:** If there's any odor or high temperature during charging, please stop charging immediately and contact after-sales team for assist.

## 2.4 Battery Installation & Removal

---

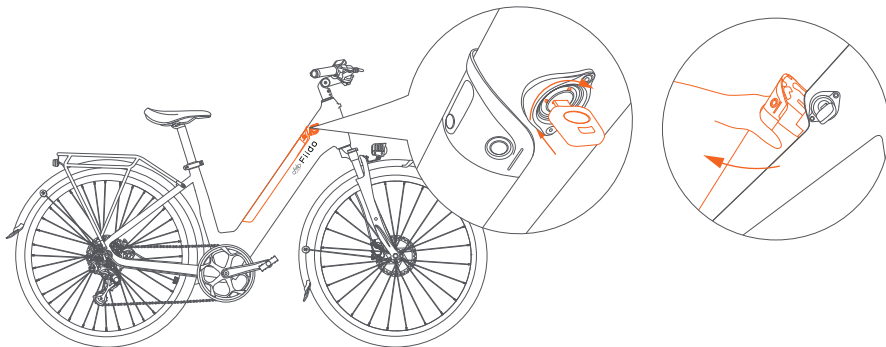

- ① Remove the battery: Turn the key clockwise to the "unlock" state, the upper end of the battery will automatically pop out and ready to be removed.

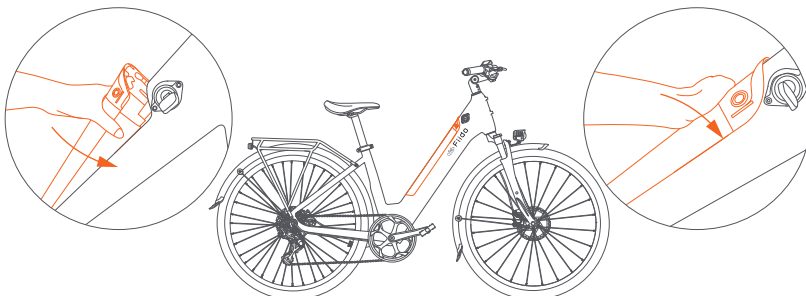

- ② Install the battery: put the lower part of the battery into the slot, then press it down. The battery will be locked in the frame.

## **3.Regular Maintenance**

3.1 Using precautions

3.2 Bike maintenance & repair

3.3 Motor maintenance & repair

3.4 Battery maintenance & repair

3.5 Reflex reflector cautions

## 3.1 Using precautions

### ( I ) Users should pay attention to the safety of bicycle use

1. No parking in building foyers, evacuation stairs, walkways and safety exits.
2. No charging in residential buildings. Charging should be far away from combustible, and no longer than 9 hours.
3. Prevent water from entering electrical parts. When cleaning the bike, avoid water impact on charging port, wiring harness connectors, fuse and other electrical parts.
4. When adjusting the height of the saddle, the safety line mark of the seatpost should not be exposed.
5. Users and dealers must not wiring and modifying structure and performance without permission. Such as: change the battery configuration, the circuit, increase the lamp power, increase the sound and other modification.
6. Please do not change the instrument background parameters settings at will, otherwise normal riding cannot be guaranteed.
7. Please do not unplug any live wire interface in the powered-on state to avoid damage to accessories (such as instrument panel, controller, etc.)
8. Do not touch the live part of the bike with wet hands or metal conductors. Such as: charging port, charger plug etc.
9. When replacing circuit breakers or fuses, use circuit breakers or fuses of the specified models and specifications. Do not short-fuse wires. The circuit breaker or fuse card slot should be in good contact, or may cause the accidents.
10. Please do not disassemble electrical parts without authorization to prevent liquid and metal particles from infiltrating into electrical parts.
11. Do not ride on bad weathers, or place the bike in a long-term exposure to the sun/rain to avoid parts aging.
12. If scrub the bike is needed, please wipe the body with a neutral lotion mixed with tap water. Do not remove and wash internal parts to avoid short circuit.

Caution: Non-professionals are strictly prohibited to repair. In case of failure, please contact the after-sales team or authorized professional maintenance station for maintenance.

### ( II ) Riding safety: please follow the national and local traffic laws and regulations, pay attention to riding safety.

1. User must be over 16 years old. Do not lend to people who can not operate the bike to avoid the harm.
2. Please ride in Non-Motor Vehicle Lane, with the max speed no more than 25km/h.
3. Please carry persons or goods in accordance with local laws and regulations while riding.

4. Please be sure to wear a suitable safety helmet and fasten the helmet wind strap while riding.
5. The braking distance will be extended in rainy and snowy days, please pay attention to slow down, and try to avoid to ride on bad weathers. Inner short circuit and electrical parts damage may be caused if the water level reaches the center of the hub of the rear wheel motor, please noticed.
6. Please follow the local traffic rules carefully. No riding after drinking, and make sure to always ride with both hands.
7. Bright colors, relaxed, and comfortable suit are suggested for riding, and wear low-heeled shoes for riding is necessary.

### **( III ) Examination before riding: please repair in time or go to the local maintenance point for repair, if there's any abnormality.**

1. Please confirm the normal power use when using the kickstand and the rear wheel is off the ground.
2. Turn on the power, check whether the indicator light is normal, and the power supply is sufficient.
3. Check whether the mechanical bell and front/rear light are in good condition.
4. Confirm whether the handlebar and seatpost are adjusted to the appropriate position, that fastening screws and quick release are fastened. Be attention that the safety line should not be exposed.
5. Check the front/rear brake handle, brake adjustment should make the brake reliable and flexible reset.
6. Check whether the tire pressure is normal, no cracking, abnormal wear, nails, stones, glass and other sharp objects.
7. Check whether the front/rear wheel screws are locked, the side, rear and pedal reflectors are in good condition.
8. Check whether the front /rear lighting is normal and ensure that lights can be good used while riding.
9. Check the fastening state of each axle to ensure the front/rear axles are in a reliable state.
10. Check whether the frame clamp is locked before riding.

**Caution: abnormal tire pressure, tire cracking damage and abnormal wear are the main causes of steering failure and tire burst.**

## **(IV) Attentions on the road**

1. For your safety and the safety of others, please obey the local traffic rules consciously.
2. Before riding, be sure to wear a safety helmet, take safety precautions and maintain a natural posture.
3. At the beginning of riding, please slowly accelerated, to avoid the energy waste or accidents.
4. For a longer service life of the battery and motor, when start riding or climbing, please try to use power assisted mode.
5. To ensure safety, economic speed should be used as far as possible, and reduce frequent braking, frequent start as far as possible, to save electricity.
6. avoid the phenomenon of tightening the speed control handle after braking.
7. Riding on muddy areas or uneven roads should use pedal mode as far as possible.
8. Braking distance should be appropriately increased on bad weathers, please be concentrated and careful while riding.
9. Equipped with overcurrent protection. The circuit may be overcurrent under the condition of higher uphill Angle and higher headwind speed. It's better to use pedal mode, otherwise, power consumption may be too fast to affect the range, motor and electrical appliances burn. The body and electrical parts should not be electriferous, the insulation resistance value shall not be less than 2M  $\omega$ .
10. Controller has undervoltage protection, the power will be cut off automatically if the voltage is lower than the undervoltage value, to maintain the service life of the battery.

## **( V ) Attentions of pushing and parking**

1. The power should be off when pushing the bike, to avoid the accidents.
2. Parking should be on the level ground, and maintain the bike as power off status.
3. For your safety, please maintain and clean your bike regularly to keep it in the best condition.



## 3.2 Bike maintenance & repair

1. The bicycle has been checked and adjusted before out of factory, any problems please contact Fiido After Sales Team for support.
2. Normally the spokes of the wheel should be adjusted once after half a month of riding to ensure the best use.
3. Make sure to check the storage capacity of the tire regularly to keep it in normal use.
4. Make sure to check the main parts like handlebar, stem, saddle, seatpost, front/rear and centre axle, flywheel and chain, wheels, to keep it in normal use, nut and screw loose should be tightened in time if it loose.
5. In use, it's recommended to add 3# calcium base lubricating oil (butter) every six months to the parts that need lubrication. (such as front/middle/rear axle bearing, front fork bowl group, foot pedal bearing, etc.) Add 30# oil to the chain, brake cable, support and other parts every two months.
6. If the vulnerable parts are damaged, such as: brake line, brake skin, brake pad, bulb, fuse, etc. Please find the local maintenance center to replace, but be sure to replace with the same model specifications of the parts.

**Cautions:** Handlebar core screw fastening torque, combined handlebar joint screw fastening torque, saddle clamp screw fastening torque, front wheel fastening torque recommended torque is not less than 18NM; The recommended torque for fastening the central shaft lock mother and rear wheel is not less than 30NM. Handlebar and saddle tube safety line should not be exposed outside the body.

## 3.3 Motor maintenance & repair

1. Equipped with rare earth permanent magnet DC brushless, external rotor hub motor, without any deceleration mechanism and carbon brush, which is basically maintenance-free.
2. Do not open the motor base and end cover after sealing.
3. Keep the motor clean, no foreign matter, corrosive liquid, gas into the motor, do not knock and bake the motor shell, so as not to damage the motor.

**Caution:** If the issue still exists, please contact Fiido customer care team.

## 3.4 Battery maintenance & repair

1. Lithium battery has the characteristics of large capacity, long life, maintenance-free, light weight, pollution-free etc. Its service life is closely related to using mode. Do not store chronically, please form the habit of frequent charging.
2. It is recommended to charge for 5 - 7 hours each time, and the longest time is not more than 1 day. Lithium battery has no memory effect, can be used with the charge.
3. Make sure to charge for more than two hours every month under chronically store condition. Do not store the battery at a loss of power. Once the battery voltage reaches the discharge state, will cause unrecoverable damage.

**Danger:** Do not dismantle old battery without authorization, it should be collected according to regulations.  
**Warning:** Do not near the fire or high temperature source, or throw it into the fire, or expose it to the sun.

## 3.5 Reflex reflector cautions

1. Reflex reflector device must not be missing, if it's missing, please immediately contact after-sales team for replacement, and the installation position should be consistent with the original bike.
2. Fiido reflex reflector has been fixed on the vehicle, please do not change the position, modify, disassemble, etc.
3. Make sure to check the normal function of reflex reflector before each use, and keep the surface clean.
4. The reflector device must not be covered by luggage, children's chairs, clothing and other objects, otherwise it may cause safety hazard.

## **4.After-sales Service**

4.1 Troubleshooting methods

4.2 Specifications

4.3 Warranty coverage

4.4 Repair record

## 4.1 Troubleshooting methods

### Fault code description

Fault code	Fault phenomenon
E1	Communication issues
E2	Throttle issues
E3	Brake lever issues
E4	Motor hall issues
E5	Motor issues
E6	Controller issues
	Overheating protection

### General fault

Fault phenomenon	Fault cause	Rule out way
Through-supply motor failure	Poor contact of regulating handlebar Poor contact of brake cut-off switch Motor damage Controller damage Loosened connector	Change regulating handlebar Change brake cut-off switch Change motor Change controller or get repair Check the connector
Lack of range	Tire pressure deficiency Undercharged or faulted charger Aging battery or damaged battery More uphill, gale, frequent braking, overload, etc	Blow up the tire Fully charged, check charger Change battery Using pedanal mode
Difficulty in charging	Loosened plug Disconnected battery cable Damaged charger	Tighten socket and connector Welded connector Change charger

## 4.2 Specifications

Property index	Item	C11
Product size	Before folding: Length*Width*Height (mm)	1820*670*1150
	Tires (mm)	700*40C
Product weight	Net weight	24.5kg(54lb)
Riding requirement	Maximum load	120kg(265lb)
	Applicable age	16+
	Applicable height	155cm(5'1") - 195cm(6'5")
Main spec	Serial numbe Location	Under the frame
	Maximum speed	15MPH (25km/h)
	Center distance between wheels (mm)	1115
	Power assisted system	3/5 gears
	Transmission ratio	52T:11~32T
	Applicable road	Urban asphalt pavement/flat pavement
	Operating temperature	-10° ~50°
	Waterproof rate	IP54
	Rated voltage (V)	48
Battery	Battery type	Lithium battery
	Rated capacity (Wh)	499.2
	Battery management system	Overheat/short circuit/ overcurrent and overcharge protection

Motor	Torque (N·m)	55
	Rated speed (r/min)	325
	Motor type	Brushless geared motor
	Undervoltage protection (V)	40±1
	Overcurrent protection (A)	18±1
Charger	Input voltage (V)	100-240
	Output voltage (V)	54.6
	Output current (A)	2
	Charging hours (h)	5
Others	Front light	LED
	Tail light	LED
	Riding mode	Electric mode+Power assisted mode+Pedal mode

**Caution:**

\* The above data allow for 5% manufacturing tolerances.

\* After receiving the bike, there may be some differences between individual accessories and display drawings, which are different due to the different batches, and do not affect the use.

## 4.3 Warranty coverage

### ( I ) Warranty principle

1. Users should operate correctly according to this user manual. In case of performance failure caused by production quality, according to relevant laws and national provisions of the three guarantees, the company shall uniformly perform the obligations of the three guarantees.
2. The faults beyond the warranty scope and the main parts after the warranty period shall be repaired by the company but shall be charged at the discretion.
3. Regards the battery replacement after the warranty period, will be charged with the factory price, but the old battery must be returned to the manufacturer, to ensure safety and avoid environmental pollution.

## (II) Warranty scope and period

Item	Parts	Guarantee time	Service
Basic parts	Frame	36 months	Natural deformation, open welding, desoldering fracture phenomenon, quality problems caused by poor manufacturing can be replaced. Self-modification, collision damage, etc. are not warranted.
	Fork, Handlebar, Stem, Seatpost	12 months	
	Kickstand, Tires, Saddles, Fenders, Safety hook, Seat clamp, Stem clamp, Frame clamp, Pedals, Brakes, Brake discs, Brake levers	3 months	Tire puncture by sharp objects, collision damage of spare parts, etc. are not warranted.
	Crank chain disc, Front arm set, Hub, Wheel hub, Spokes, Shift finger dial, Derailleur, Flywheel, Chian, Bottom bracket, Shock absorber	6 months	Man-made damage, self-modification, collision damage of parts and accessories are not warranted.
Electric parts	Controller	12 months	Short circuit, burnout, performance failure due to poor manufacturing can be replaced. Water, disconnection, and man-made damage are not warranted.
	Charger, Main wiring harness	12 months	
	Display instrument, Speed control knob, Booster, Controller cover plate	6 months	
	Headlights, Taillights, Power-off brake levers, Switches	3 months	
Motor parts	Motor, Hall, Bearing, Clutch	12 months	Phase loss, Hall element burnout, demagnetization, abnormal bearing noise can be replaced. Breakage, water ingress are not warranted.
Motor parts	Lithium battery	12 months	Replace the battery due to faults such as broken grids, no power storage, and less than 70% capacity. No warranty for water ingress or man-made damage.

## (III) The scope and content exceed warranty

1. Failure caused by user's failure to use, maintain and adjust according to the User Manual.
2. Failure caused by private modification.
3. Failure caused by improper use or storage by users or accidents.
4. No warranty card, or card and bike do not match.
5. Vulnerable parts and consumables, including plastic parts, spokes, rim, brake line, scratching surface etc.
6. The expenses for self-repair without the consent of the specially contracted maintenance unit.
7. After accessories leaving the factory, shell scratches or shell damage will not enjoy warranty.
8. Lead scratches or breaks.

## Warranty notification

1. Accessories will be guaranteed in strict accordance with the warranty period.
2. The warranty period shall be calculated from the date of delivery.
3. No warranty will be provided if the charger, battery and motor are disassembled without permission.
4. For other parts of the bike, the quality issues will be provided three months warranty , others will not be warranty.
5. When other parts of the bike has issues, maintenance must be carried out in a professional maintenance centre, not private disassembly. Controllers, batteries, chargers must be ensured that all labeling integrity.
6. maintenance must comes with the warranty card, invoice, certificate of quality and other relevant documents.
7. The battery warranty method is 1:1. In case of battery problems, the battery should be returned to the manufacturer to determine whether the battery is covered by warranty according to battery testing standards.

## 4.4 Repair record

### Warranty card

User	Company			
	Name		Phone	
Address				
Purchase date		Color		
Model		Order No		
Frame No		Motor No		

### Repair record

Date	Maintenance	Remarks

If you have any questions or suggestions about this user manual,  
please contact us via following mailaddress  
Contact us: [support@fiido.com](mailto:support@fiido.com)



Scan for video instruction



Fiido APP



EPAC according to EN 15194



6971957790754